

sapa:

buildingsystem

ARCHITECTURAL ALUMINIUM SOLUTIONS

CROWN

Welcome Home





STRONG, SAFE, SUSTAINABLE AND BEAUTIFUL

Over four decades of design expertise, knowledge and sheer passion has gone into developing our Crown system – a stunning range of windows and doors that richly deserve a place in your home.

Originality and attention to detail have long been the design hallmarks of our windows and doors and we're proud that many of our market leading designs have set the standards our industry now follows. Crown windows and doors are renowned throughout the country not just for their refined appearance, which are impressive enough, but also for their sheer strength and durability.

For our customers this has always meant they could count on our windows and doors to keep them and their families warm, safe and secure. Our commitment to building on this reputation led to the development of our Crown suite: inherently strong; outstandingly good looking; rigorously tested and designed to keep on performing year after year.

We designed our windows and doors as we would like them in our own homes, with slim, finely detailed frames that let in more light and are a pleasure to look at and use every day.

We believe that Crown is simply the best window and door system you could want for your home.



TAILOR MADE FOR YOUR HOME

Individuality inside and out

New windows and doors can completely change the feel of your home and with the ability to tailor the windows and doors through different choices of colours and accessories, ensuring that you can create your own style.

Safe and secure

Safety and security are extremely important when choosing new windows and doors to ensure the things that are most important to you are protected. We take this seriously by making sure that our windows and doors meet the highest security standards possible.

Reduce costs with increased efficiency

With the ever increasing price of fuel for the home, the right choice of windows and doors can help to reduce these costs. We have developed our products carefully and make sure that they meet the latest standards for energy efficiency.

Made to last

When you invest in your home, you want to ensure that it will stand the test of time and look as good as the day it was installed many years later. We only use the highest quality materials, fixtures and fittings within our windows and doors so that you can be assured of the very best.



ENERGY RATING A



CROWN Windows



Let the light shine into your home...

Crown windows can be made to replicate your existing windows or configured with a new arrangement of fixed and opening windows to create an individual look that is just perfect for your home.

Homeowners with listed properties, or houses that fall inside Conservation Areas and Areas of Outstanding Natural Beauty, will often find their local planning authority is happy to approve the use of Crown windows and doors due to the super slim frame design.

Our Crown windows use 'True Dual-Colour' technology affording a palette of over 400 colours for the inside and outside of your windows, to blend or contrast with your home as you wish. The finish is a high performance, non-fading, hard and durable coating that is baked onto the frames. Being low maintenance, it needs only an occasional wipe down to stay looking as good as new.

Finally, your Crown windows can be finished with an inspiring array of Georgian, leaded, patterned or stained glass highlighting distinct aspects of your home to add character or control privacy.

Features

- 'A' Rated for energy efficiency and reduced costs
- Secured by Design approved for peace of mind
- PAS 24 Security certified
- Slim profile for better aesthetics
- Virtually maintenance free finish

Available Options

- Dual colour frames for a personalised finish
- Softline profiles for a more traditional look
- Narrow 52mm profile to increase the view
- Compatible with the full Crown suite

Dimensions

Side Hung	Min 236mm x 386mm	Max 736mm x 1336mm
Top Hung	Min 386mm x 200mm	Max 1200mm x 1336mm

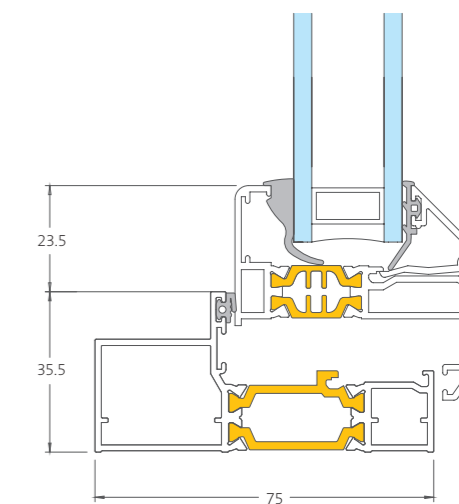

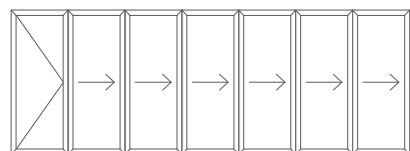
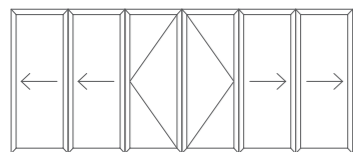
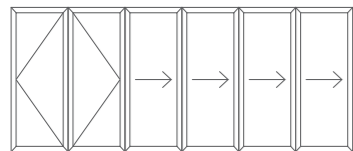
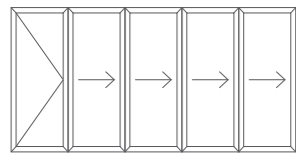
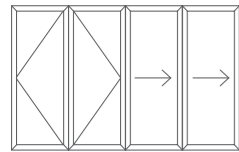
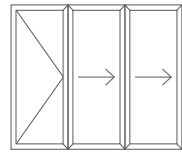
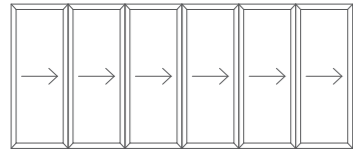
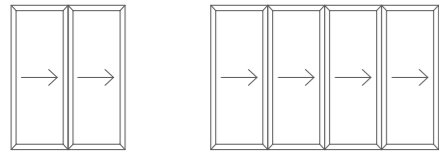

CROWN Sliding Folding Doors

Extend your living space...

Open up your home with an aluminium sliding/folding door. It's a great way to bring your living space and garden together, opening up wonderful new possibilities to make the most of your home.

Enjoy a summer barbecue, or just relax and enjoy the view. And then, as the nights draw in, the high levels of insulation and security will keep everything comfortable and safe indoors. Our versatile mixture of hinged and folding leaves is designed to give you perfect control over the way that you use the door.

Crown sliding folding doors all feature advanced technology – combining the structural integrity of aluminium with a thermally insulating polyamide, keeping you insulated from the elements.

Features

- Multipoint lock so that the door can be locked securely and also be used as a main entry point
- Continuous hinge for a seamless finish and prevention of fingers becoming trapped during operation
- Innovative shootbolt handle for additional security and peace of mind
- Easy-glide stainless steel wheels and track for smooth operation
- Open in and out, left and right hand to suit personal requirements
- Magnetic catch to hold the door open for safer operation

Available Options

- 2, 3, 4, 5, 6 and 7 pane configurations
- Attractive light oak wood finish
- Dual colour frames for a personalised finish
- Low threshold cill to ease access
- Compatible with the full Crown suite
- Up to 3 metres high

Dimensions*

Standard Threshold	Min 1856mm x 1268mm	Max 3000mm x 6426mm
Low Threshold	Min 1824.5mm x 1268mm	Max 2968.5mm x 6426mm

*Based on overall dimensions, configuration options should be checked for individual size limitations

UP TO 3 METRES HIGH



Light Oak Finish

DUALSECURE LOCKS



CROWN Hinged Doors

Doors that last and make a lasting impression

Our single and double doors have been designed to fit anywhere in your home with 'front' and 'back' door options. Whichever you choose, you can be assured that when you lock your doors they will secure your home every time.

Crown Entrance Doors and Double French Doors close quietly on minimally intrusive hinges, whilst our sliding patio doors glide easily on high-strength twin stainless steel rollers. All of our doors have the same highly insulated frames as Crown windows and, because they are made from aluminium, they do not expand or shrink, fitting snugly into their frames, ensuring there are no draughts and, from a security point of view, no vulnerable gaps.

Features

- Elegant design with slim sight lines
- Virtually maintenance free
- Multi chamber for strength and thermal performance
- Dualsecure locking system for peace of mind
- PAS 24 Security certified

Available Options

- Dual colour frames for a personalised finish
- Low threshold cill to ease access
- Narrow 52mm profile to increase the view
- Compatible with the full Crown suite

Dimensions

Single Doors

Standard Threshold	Min 600mm x 1879mm	Max 1074mm x 2230mm
Low Threshold	Min 600mm x 1860mm	Max 1074mm x 2211mm

Double Doors

Standard Threshold	Min 1133mm x 1879mm	Max 2082mm x 2230mm
Low Threshold	Min 1133mm x 1860mm	Max 2082mm x 2211mm

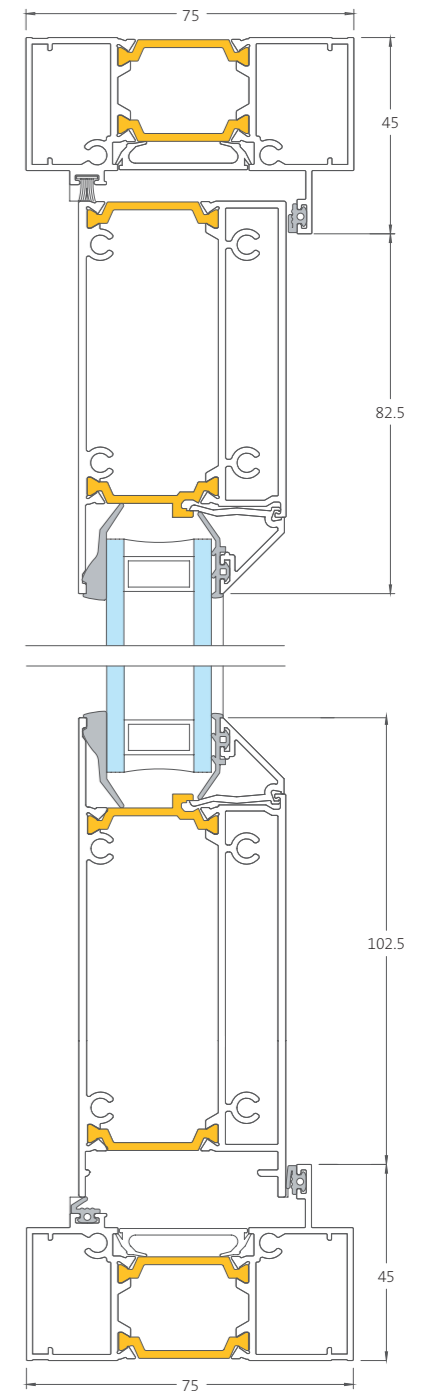

CROWN Sliding Doors

Best views and maximum light...

Our Crown Sliding Patio Doors are key to bringing together the inside of your home with the outside. Engineered for strength and stability, these wide opening doors with their strong yet slim frame design allow you to enjoy the best views and maximum light to flood in.

We have designed our sliding patio doors with a multipoint lock system providing additional security features around the doors to ensure they deliver all round security for peace of mind.

Sliding patio doors can be made up as 2, 3 or 4 panes. For a bigger and wider prospect, consider the stunning view you could create with our Sliding Folding Door which have the option to extend with a number of extra panes – opening up a doorway or perhaps even a whole side of your home.

Features

- A+ energy rating for excellent thermal efficiency
- Slim frame for better sight lines
- Stainless steel track and wheels giving easy glide operation
- Up to 2.4 metres in height for more sunlight
- Integral air vent for improved ventilation

Available Options

- 98mm and 120mm frame option
- 2, 3 and 4 pane options
- Dual colour frames for a personalised finish
- Choice of finishes for accessories
- Compatible with the full Crown suite

Dimensions*

98mm Frame	Min 1505mm x 1830mm	Max 6353mm x 2500mm
120mm Frame	Min 1530mm x 1830mm	Max 6400mm x 2500mm

*Based on overall dimensions, configuration options should be checked for individual size limitations

ENERGY RATING A+

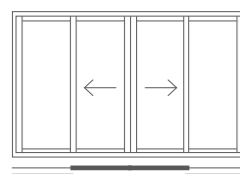
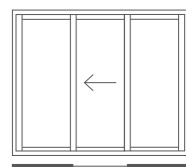
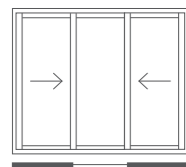
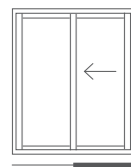

DOOR AND WINDOW ACCESSORIES

Styling is all about taking care of the details, and the handles of your windows and doors have been as carefully thought through as every other aspect of the Crown system.

Designed and manufactured by one of Europe's leading manufacturers of door and window handles, we offer an extensive and imaginative range of handle colours to complement or contrast with the frame colour you choose. All of our handles can also be colour matched so your windows will match your doors – we know it's only a small thing, but we believe it's this attention to detail that really counts.

Silver

Matt black powder coated

Gold

Pure white powder coated

Polished chrome

Polished gold

Lever/Lever Pad Set

Aluminium lever set on backplate for exterior doors. To suit multipoint locks. Aluminium lever and backplate.

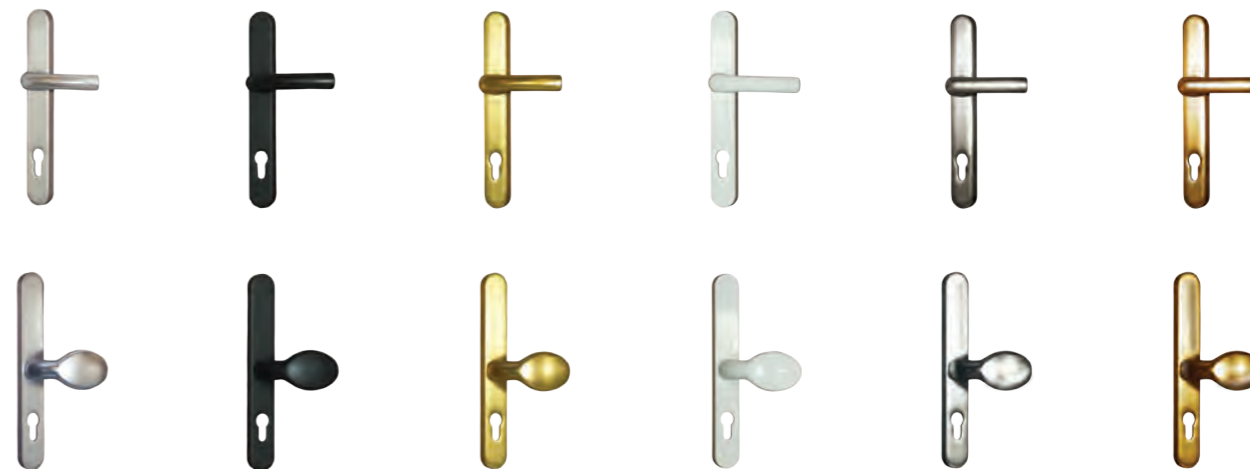

Sliding Door Handles

Aluminium D handle is set on backplate for exterior use. All sliding door handles suit the multipoint locking mechanism with a lever to operate lock.



Inline locking handle - window

Aluminium lockable window handle with 90° stop position, for espagnolette window locks. The inline lever is fixed to the backplate.



Offset locking handle - window

Aluminium lockable window handle with 90° stop position, for espagnolette window locks. The cranked lever is fixed to the backplate and by design is handed.

In operation the handle is opened by pushing the cylinder button. Handles lock automatically when closed, For additional security the cylinder can also be deadlocked with the key. Fixing screws are concealed. Also available: Cylinder cover for non locking applications.



COLOURS AND FINISHES

As well as our 'standard' range, we have a superb collection of over 300 premium colours for you to consider.

From neutral tones to metallic finishes, you can opt for the same colour throughout, or choose different colours for the inside and outside of your window and door frames to create the perfect, individual and stylish look.

Whatever your colour preference, you will enjoy the benefits of one of the most durable finishes available for windows and doors. The low maintenance of our window and door finish means it will need only an occasional wipe down with soapy water to keep it looking as good as new.



Safety in mind

Various British Standards and Building Regulations allow for or stipulate that certain windows must be restricted in their initial opening for reasons of child safety, or be usable as a fire escape.

With Crown windows these needs can be met by means of optional hinges, handles and catches.

Furthermore some hardware allows windows to be safely cleaned from inside the building. Compliance with these requirements depends on the design of your specific property so always ask us for details.

Locking security

Our security features coupled with the inherent strength of aluminium makes Crown windows and doors a truly secure choice. Your home is simply and effectively secured through high strength, multipoint locks with one simple handle action and a central key.



Security features

Sliding patio doors have anti-lift devices to prevent the lifting and removal of the sliding panes, and interlocking stiles to restrict the doors from being prised apart. The locking mechanism consists of 6 centre hooks operating on a stainless steel faceplate providing strength and a long lasting finish. The lock contains an anti-slam device meaning that you are unable to inadvertently shut the door with the hooks in the “locked” position and cause damage to the faceplate.

The hinges on our entrance doors feature a unique interlocking action which coupled with the 3 hook locks operating in opposing directions, means that your door cannot be twisted from its frame. Once more the faceplate is stainless steel. The centre latch combines with a “snib” function to allow you to close the door behind you without locking yourself out when using lever/pad handles.

Our unique “Dualsecure” locking system (Patent Pending) also includes a 5 Lever security “lock out” function to deadlock the lock independently of the cylinder. This additional feature restricts the movement of all locking parts and provides you with exceptional levels of security. To ensure easy egress in case of emergency, such as fire, we provide this deadlock function with an easy to use thumbturn option on the inside meaning you do not need to keep additional keys and can exit quickly and safely should you need to. To ensure we provide the very best in weathering, the outside escutcheon for the deadlock has an ingenious internal shutter system which restricts air flow meaning that your additional lock is draft free.

When combined with our high security cylinder (which complies with BS1303 as required by many insurers) this combination can also meet the stringent requirements of BS8621 and BS10621.

All these features provide the most comprehensively secure window and door system to make your home safe.



ENERGY RATINGS EXPLAINED

As part of the Government's commitment to improving energy efficiency in this country, all windows and doors have to meet strict performance criteria for how well they insulate your home. Windows are awarded a Window Energy Rating (WER) by the British Fenestration Rating Council (BFRC). Similar to that used on white goods such as fridges and washing machines, an energy efficiency is calculated and a WER awarded B rating or above is endorsed by the Energy Saving Trust. Doors have to meet a specific 'U' value of 1.8 W/m²K, which is a measure of heat loss through the door.

Crown windows achieve the highest WERs – A, B, or C dependent on the chosen frame and glass combination – with calculations carried out by our own BFRC registered simulator. All of our doors meet and in most cases exceed the required 1.8 W/m²K 'U' value.

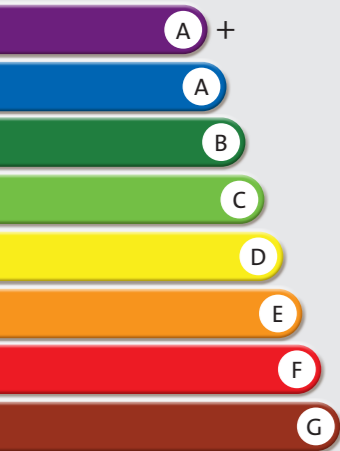

SECURED BY DESIGN

Security has always been at the forefront of Crown window and door design and we understand that security equals peace of mind. This is why we incorporated high performance, multipoint locking AS STANDARD into all of our windows and doors, which meet and exceed two crucial industry security standards – BS7950 for windows and PAS24 for hinged entrance doors. Your insurance company will be satisfied as our Crown system fulfils the Police Approved Specification as 'Secured by Design'.



A LONG WORKING LIFE AND THE GREENEST CREDENTIALS

Designed and manufactured to high quality industry standards, Crown windows and doors won't warp, twist or swell and will never rot or rust. Whilst nothing is completely 'fit and forget', the maintenance required to keep your Crown windows and doors performing and looking as good as the day they were installed, is genuinely minimal.

The latest UK Building Regulations for windows and doors place high demands on thermal performance, which is why the integral thermal efficiency of the Crown system not only meets, but exceeds the required standard, saving you money on your energy costs every single day.

Aluminium is something of a wonder material which is why it is used in so many different ways. Once it has come to the end of its useful life it can be recycled again and again and again – in fact it can be re-used infinitely, which makes it one of the greenest building materials available.

THE ENVIRONMENTAL CASE FOR ALUMINIUM

- 75% of all aluminium produced since the 1880s is still in use
- Mined from resources close to the surface
- Aluminium can be recycled again and again without loss of quality – a unique property compared to other materials
- 50% of aluminium smelting from bauxite uses hydro-electric power
- It only takes 5% of the original energy used to recycle aluminium
- 70%-98% of aluminium used in today's buildings will eventually be recycled



Source: Council for Aluminium in Building Website, June 2015



SAPA ACCREDITATIONS

Crown windows and doors have been developed by Sapa Building Systems who are part of the worldwide Sapa Group with over 23,500 employees in 40 countries.

We have spent over 50 years, researching and developing our window and door systems. Our passion and commitment for exceptional quality is assured through the many professional accreditations, certificates and licences that we have been awarded and is your guarantee of the finest windows and doors.

Secured by Design



Official Police Security Initiative



PAS 24-1 Licence No. KM90215
 BS 4873 Licence No. KM74159
 PAS 23-1 Licence No. KM90215



Enhanced Security
 Doorsets PAS 23 and 24
 Certificate Number 044

Enhanced Security Windows
 BS7950 and BS4873
 Certificate Number 034

Aluminium Windows
 BS 4873
 Certificate Number 001



BSI Registered firm Licence No. FM0114



ISO 14001 Certificate Number EMS 562855

sapa:

buildingsystem

ARCHITECTURAL ALUMINIUM SOLUTIONS

Sapa Building Systems Ltd is a member of the worldwide Sapa Group, which has over 23,500 employees, in more than 40 countries across the globe. The core business is the development and distribution of aluminium profile systems. Sapa Building System aims for well-developed systems and project solutions, offering a tangible added value to fabricators, architects, investors and home-owners.

WINDOWS AND DOORS

SLIDING SYSTEMS

CURTAIN WALLS

BUILDING INTEGRATED PHOTOVOLTAICS

YOUR SAPA BUILDING SYSTEM CONSTRUCTOR

SAPA BUILDING SYSTEMS LTD
Severn Drive, Tewkesbury, Gloucestershire. GL20 8SF | T 01684 853500
The Building Centre, 26 Store Street, London. WC1E 7BT | T 0207 636 4186
info@sapabuildingsystems.co.uk | www.sapabuildingsystems.co.uk



C5230 0815